

RATTICUS

PCB V1.0

BUILDER'S MANUAL

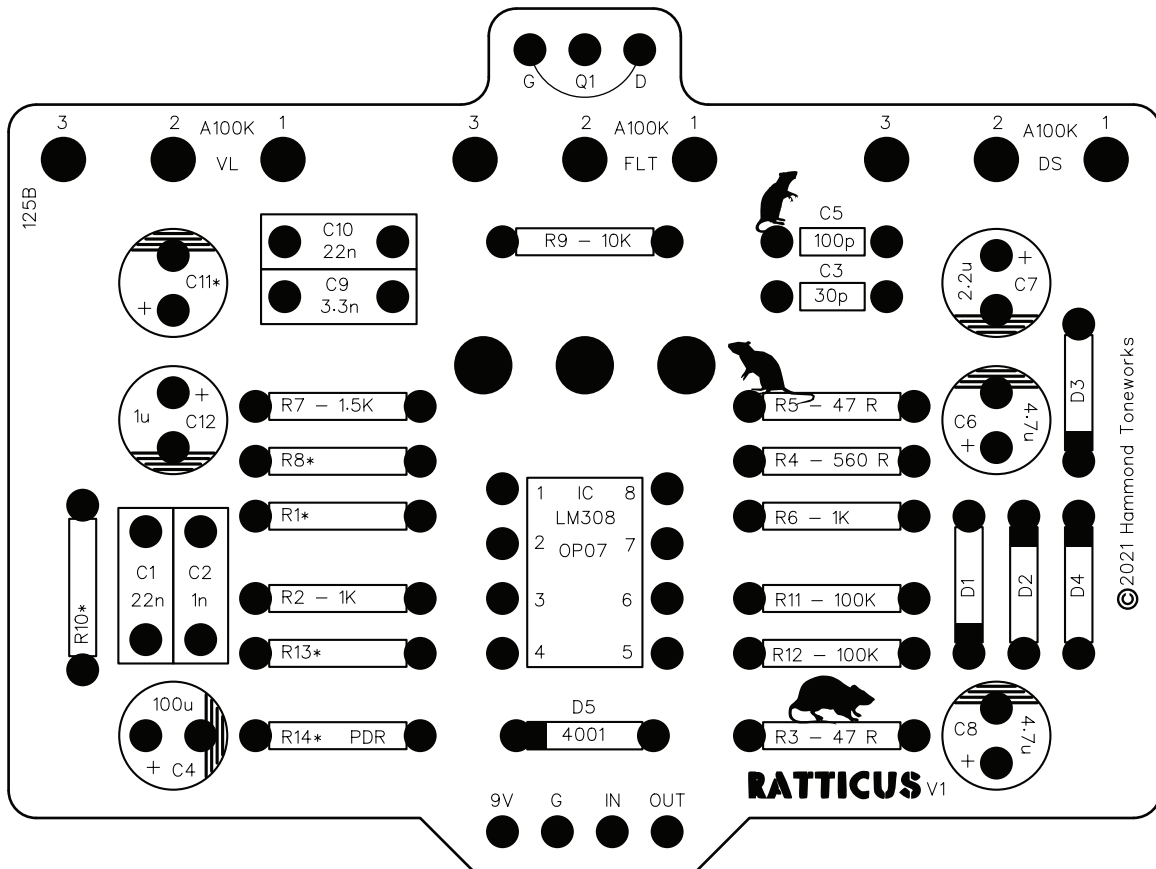

TABLE OF CONTENTS

1. Title Page
2. General Build Notes
3. 16mm Pot Adapter Board Info
4. 3PDT Daughterboard Info
5. Circuit Info
6. Bill of Materials
7. Onboard Wiring / Component Layout
8. Offboard Wiring (3PDT PCB)
9. Offboard Wiring (No 3PDT PCB)
10. Schematic
11. Drill Template



PCB boards designed to allow direct mount 90 degree potentiometers

Dimensions (W=53.34 mm x H=40.01mm)
Recommended enclosure 125B

Drill Template: HT125B-RT-08, HT125B-RT-12
HT125B-RN-08, HT125B-RN-12

For a downloadable PDF copy of this manual, visit www.hammondtoneworks.com/support

DISCLAIMER:

All board layouts have been tested and verified. While I do offer a guarantee on the functionality of purchased PCBs, there is an understood assumption that the end user (you) have the knowledge and skill required to assemble the product and accept any risk involved with assembling the provided boards or parts. This understood skill level includes knowing how to properly solder, troubleshooting steps, etc. If you have any questions concerning any Hammond Toneworks products, feel free to send a message on the platform of purchase, or contact support at support@hammondtoneworks.com

COMMERCIAL USE:

You may use Hammond Toneworks PCBs in commercial projects as long as the completed project is not sold as a Hammond Toneworks branded pedal, and the model name of the PCB is not used on the enclosure. Crediting the use of the PCB is not required. PCBs are not be resold as an item themselves.

Hammond Toneworks PCB boards are manufactured to accomodate the following recommended components

- Resistor:** 1/4w metal film or carbon film resistors
(7.62mm lead spacing on all resistor connections)
- Film Cap (B):** Film box type capacitor
(5mm lead spacing unless otherwise noted)
- Cer Cap (M):** Monolithic ceramic capacitor
(5.08mm lead spacing, ceramic disc capacitor can be used as a substitution)
- Cer Cap (D):** Ceramic disc capacitor
(2.54mm lead spacing)
- Elec Cap:** 25V Electrolytic Capacitor recommended, unless otherwise noted (50V caps recommended if using over 9V power)
(2.54mm lead spacing)
- Transistor:** All transistor holes are spaced to 2.54mm for easier soldering
(2.54mm lead spacing)
- Diode:** 6.32mm-7.62mm lead spacing and 0.9mm hole diameter on PCB
- Pots:** Potentiometers are to be connected to the effect board directly. Common 16mm right angle pots are recommended.
(5mm lead spacing) NOTE: Potentiometer hole diameters are sized to allow pots to be connected via wire if preferred.
- Wires:** Wiring connection holes are drilled to 1mm diameter and are spaced 2.54mm apart.
Use of 24G wire is recommended for easy assembly

RECCOMENDED ASSEMBLY ORDER**1. EFFECT BOARD ASSEMBLY**

- Solder small components first (resistors, diodes, etc) then work your way up to soldering the tallest components , then potentiometers, and finally the connection wires to the 3PDT daughter board (if used) NOTE: This is the general order of assembly, if any particular board is assembled easier using a different oder, it will be noted in the respective build docs.

2. OFFBOARD WIRING

- Refer to the recommended offboard wiring methods on pages 8 or 9 (depending on your preference)

16mm PCB PIN POTENTIOMETER ADAPTER BOARD

Optional potentiometer adapter boards are available for purchase directly or via our Reverb store. These allow a secure connection with potentiometers that have a straight pcb pin type connection and to help organize offboard wiring. **These adapters are optional, and only recommended if the potentiometers in use do not have solder lugs or are unable to be connected directly to the pcb.**

NOTE:

It is easier to attach the wires to the adapter boards first, then solder the potentiometer to the adapter board **LAST**. Attach the wires to the front side of the PCB with the Hammond Toneworks logo, and attach the potentiometer to the rear side of the PCB that is marked with "POT THIS SIDE".

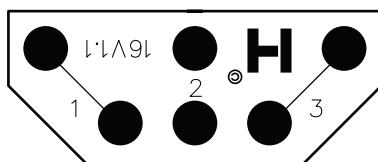

FRONT

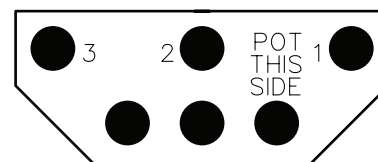

REAR

ASSEMBLED

(SHOWN WITHOUT WIRING)

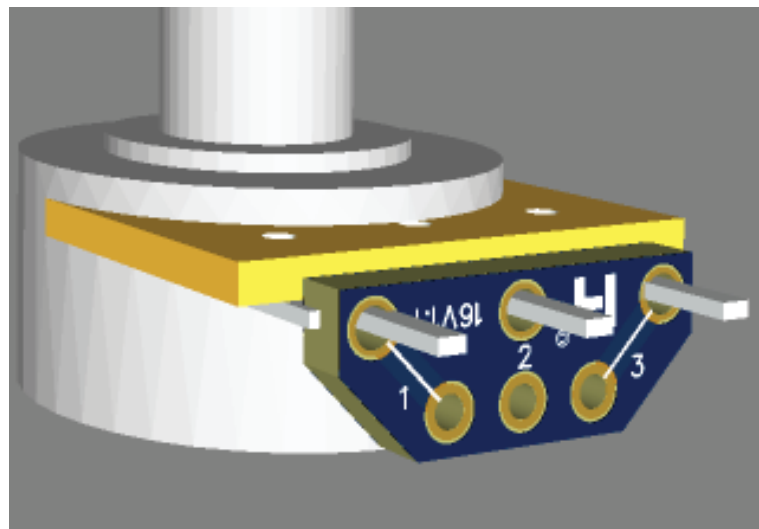
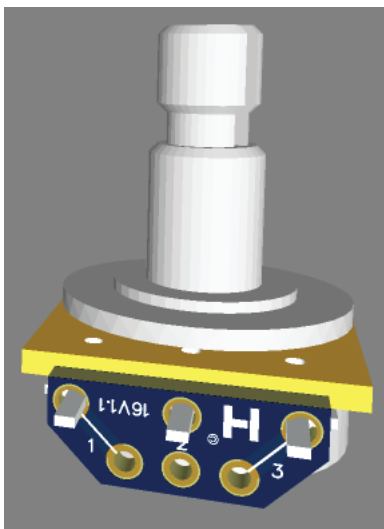

3PDT DAUGHTERBOARD PCB

Included with your board is an optional 3PDT daughterboard PCB (compatible with enclosure sizes 1590B and larger) to help organize offboard wiring and simplify connections to the main circuit. Follow the wiring diagrams on pages 7 & 8 if using the 3PDT PCB daughterboard.

NOTE:

Attach all PCB connections and components first, then solder the 3PDT switch to the 3PDT PCB board **LAST**. This is necessary due to the fact that the switch itself blocks access to some of the onboard soldering points located on the daughterboard to save space. Assemble the components and wires to the front side of the PCB with the Hammond Toneworks logo, and attach the 3PDT switch to the reverse side of the PCB that is marked with "3PDT THIS SIDE" wiring points are labeled on both sides of the PCB for ease of assembly. This page references the current v2.3 PCB, the the older v2.2 PCB is the same except for the input hole location.

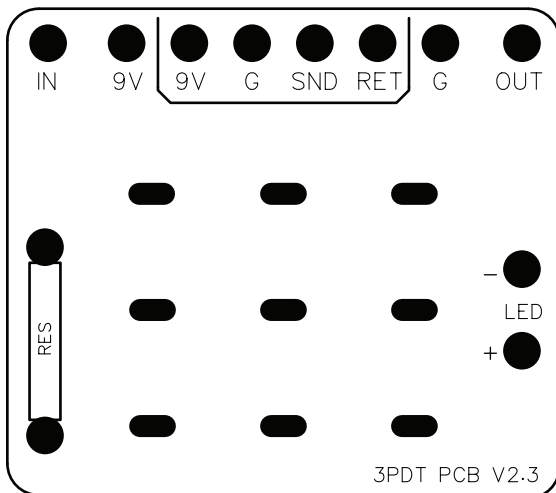

FRONT

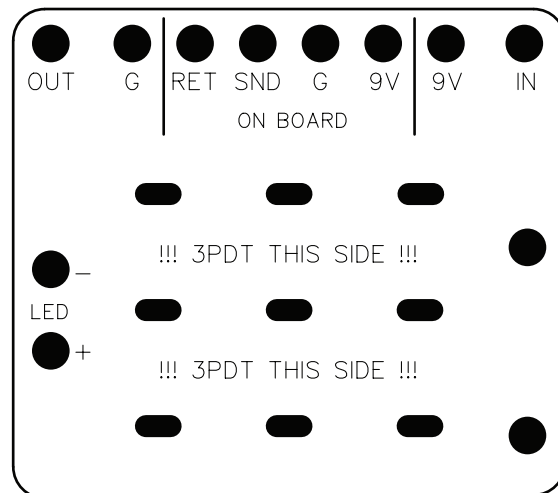

REAR

LAYOUT

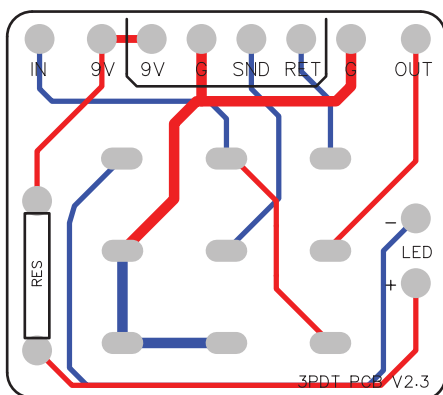

ASSEMBLED

(SHOWN WITHOUT WIRING)

RATTICUS

Based on a legendary black box distortion that should be in every guitarists arsenal at least once. This circuit can get into fuzzy distortion territory as well. The Ratticus PCB allows you to build various circuits including the original *Rat**, *Rat 2**, *Turbo Rat**, *Rat Reissue** and *You Dirty Rat** all with an added three way toggle switch to swap between various clipping options on the fly. The two outer toggle positions swap between clipping diode pairs of your choice. The middle toggle position is reserved for the boost function, which takes the clipping diodes out of play and relies on the op amp itself for gain and clipping, giving a louder signal to boost other pedals as well.

CONTROLS

DISTORTION:

The DISTORTION control adjusts the amount of op amp gain prior to the diode clipping section. Turn clockwise to increase the amount of distortion.

FILTER:

The FILTER control works in reverse of common tone controls found in pedal circuits, as it is simply an adjustable low pass filter located directly after the clipping section. Turn clockwise to allow more low frequencies through the output section of the circuit.

VOLUME:

The VOLUME control adjusts the overall output volume of the circuit. Turn clockwise to increase the output level of the circuit.

TOGGLE SWITCH:

The toggle switch on the Ratticus is intended to give various clipping options. This circuit is designed to switch between three clipping modes D1/D2 pair, Boost (strictly op amp clipping), and the D3/D4 pair. Which diodes to use are completely up to you, refer to **page 10** in this manual to find a chart listing the stock clipping diodes per their respective circuit version. This toggle switch can also be replaced with a SPST ON-ON switch to allow only two clipping modes, or omitted completely if you prefer to stick to one circuit version via jumpering the connection as explained on **page 7**.

** Hammond Toneworks is in no way affiliated with ACT Entertainment or ProCo Sounds*

This page contains values according to the "original" version of this circuit

BILL OF MATERIALS

Bill of Materials	RESISTOR	FILM CAP (B)	CER CAP (M)	ELEC CAP	TRANSISTOR	DIODE	IC	POTS	OTHER									
	2	47 R	1	1n	1	30p	2	1u	1	2N5458	1	1N4001	1	LM308	3	A100K	1	SPDT
	1	560 R	1	3.3n	1	100p	1	2.2u			2	1N914		/ OP07				ON/OFF/ON
	2	1K	2	22n			2	4.7u			2	option						
	1	1.5K					1	100u										
	1	10K																
	2	100K																
	2	1M																
1M ==>	1	(PDR)																

NOTE: Off board components are not listed (indicator LED, input/output jacks, power input jack, footswitch)

SMALL COMPONENT TABLE

(Small components may be taped down here)

RESISTORS

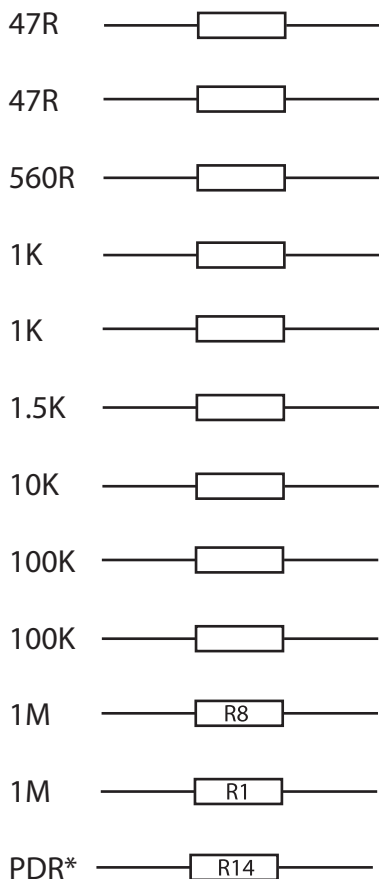

* Pull down resistor (PDR) is not present in the original circuit, it is added to help eliminate popping when the effect is powered on. Recommended value to use is 1M resistor

TRANSISTORS

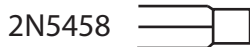

CERAMIC CAPACITORS

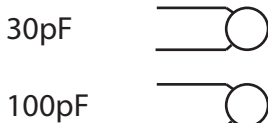

DIODES

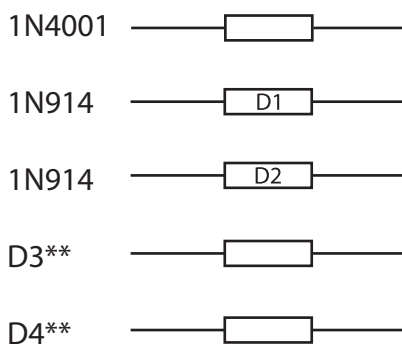

**D3/D4 are optional clipping diodes that are activated with the toggle switch. You may choose whichever diodes you prefer for these values.

OMITTED FOR THIS CIRCUIT
(leave these spots on the PCB blank)
R10, R13

FILM CAPACITORS

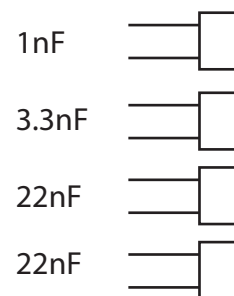

ELECTRO CAPACITORS

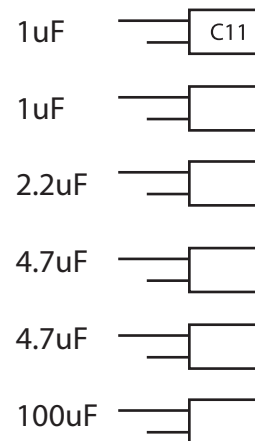

NO TOGGLE? NO PROBLEM!

If you prefer to make this circuit without the clipping selector toggle switch, simply add a jumper instead. You can refer to the toggle bypass option illustrations on page 7 for this.

This page contains values according to the "reissue" version of this circuit

BILL OF MATERIALS

Bill of Materials	RESISTOR		FILM CAP (B)		CER CAP (M)		ELEC CAP		TRANSISTOR		DIODE		IC		POTS		OTHER	
	2	47 R	1	1n	1	30p	2	1u	1	2N5458	1	1N4001	1	LM308	3	A100K	1	SPDT
	1	560 R	1	3.3n	1	100p	1	2.2u			2	1N4148		/ OP07				ON/OFF/ON
	2	1K	2	22n			2	4.7u			2	option						
	1	1.5K					1	100u										
	1	10K																
	2	100K																
	2	1M																
1M ==>	1	(PDR)																

NOTE: Off board components are not listed (indicator LED, input/output jacks, power input jack, footswitch)

SMALL COMPONENT TABLE

(Small components may be taped down here)

RESISTORS

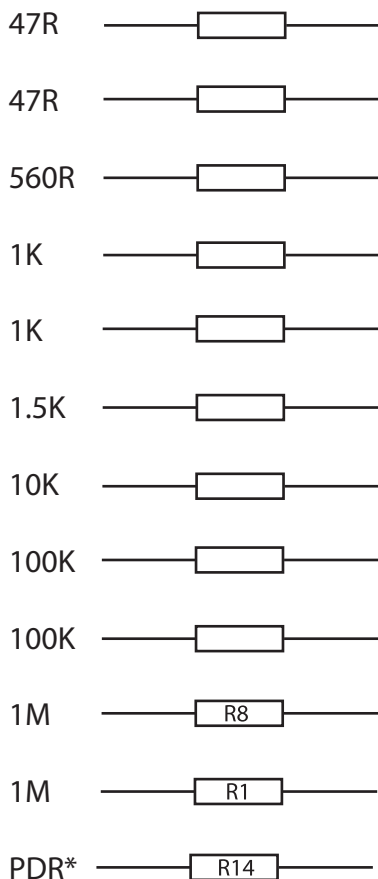

* Pull down resistor (PDR) is not present in the original circuit, it is added to help eliminate popping when the effect is powered on. Recommended value to use is 1M resistor

TRANSISTORS

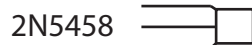

CERAMIC CAPACITORS

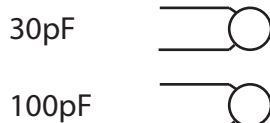

DIODES

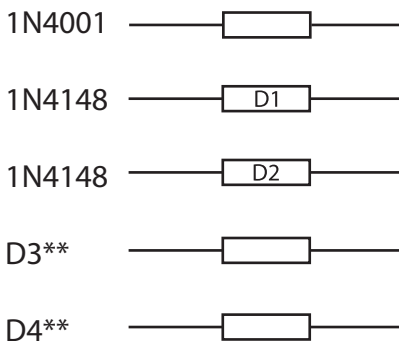

**D3/D4 are optional clipping diodes that are activated with the toggle switch. You may choose whichever diodes you prefer for these values.

OMITTED FOR THIS CIRCUIT
(leave these spots on the PCB blank)
R10, R13

FILM CAPACITORS

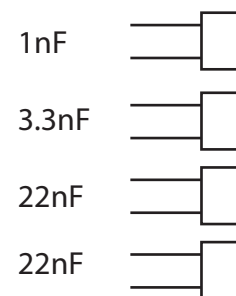

ELECTRO CAPACITORS

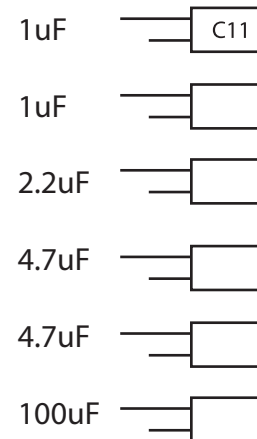

NO TOGGLE? NO PROBLEM!

If you prefer to make this circuit without the clipping selector toggle switch, simply add a jumper instead. You can refer to the toggle bypass option illustrations on page 7 for this.

This page contains values according to the "VER 2" version of this circuit

BILL OF MATERIALS

Bill of Materials	RESISTOR	FILM CAP (B)	CER CAP (M)	ELEC CAP	TRANSISTOR	DIODE	IC	POTS	OTHER									
	2	47 R	1	1n	1	30p	1	1u	1	2N5458	1	1N4001	1	LM308	3	A100K	1	SPDT
	1	560 R	1	3.3n	1	100p	1	2.2u			2	1N4148		/ OP07				ON/OFF/ON
	2	1K	2	22n			2	4.7u			2	OPTION						
	1	1.5K					1	10u										
	2	10K					1	100u										
	2	100K																
	1	1M																
	2	2.2M																

NOTE: Off board components are not listed (indicator LED, input/output jacks, power input jack, footswitch)

SMALL COMPONENT TABLE

(Small components may be taped down here)

RESISTORS

47R 

47R 

560R 

1K 

1K 

1.5K 

10K 

10K 

100K 

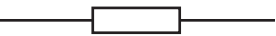
100K 

1M 

2.2M 

2.2M 

TRANSISTORS

2N5458 

CERAMIC CAPACITORS

30pF 

100pF 

DIODES

1N4001 

1N4148 

1N4148 

D3** 

D4** 

**D3/D4 are optional clipping diodes that are activated with the toggle switch. You may choose whichever diodes you prefer for these values.

FILM CAPACITORS

1nF 

3.3nF 

22nF 

22nF 

ELECTRO CAPACITORS

1uF 

2.2uF 

4.7uF 

4.7uF 

10uF 

100uF 

OMITTED FOR THIS CIRCUIT
(leave these spots on the PCB blank)
R13

NO TOGGLE? NO PROBLEM!

If you prefer to make this circuit without the clipping selector toggle switch, simply add a jumper instead. You can refer to the toggle bypass option illustrations on page 7 for this.

This page contains values according to the "turbo" version of this circuit

BILL OF MATERIALS

Bill of Materials	RESISTOR	FILM CAP (B)	CER CAP (M)	ELEC CAP	TRANSISTOR	DIODE	IC	POTS	OTHER
	2 47 R	1 1n	1 30p	1 1u	1 2N5458	1 1N4001	1 LM308	3 A100K	1 SPDT
	1 560 R	1 3.3n	1 100p	1 2.2u		2 LED	/ OP07		ON/OFF/ON
	2 1K	2 22n		2 4.7u		2 OPTION			
	1 1.5K			1 10u					
	2 10K			1 100u					
	2 100K								
	4 2.2M								

NOTE: Off board components are not listed (indicator LED, input/output jacks, power input jack, footswitch)

SMALL COMPONENT TABLE

(Small components may be taped down here)

RESISTORS

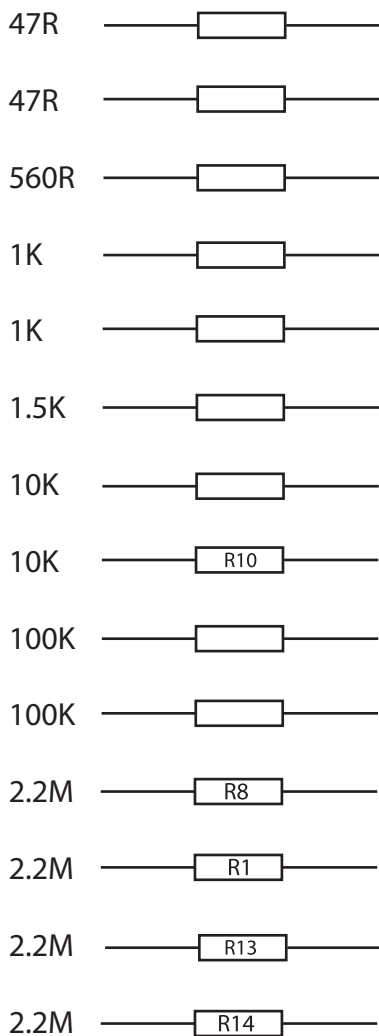

TRANSISTORS

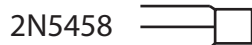

CERAMIC CAPACITORS

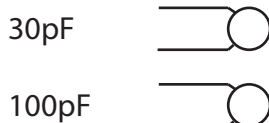

DIODES

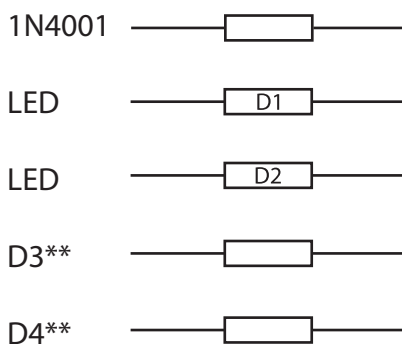

**D3/D4 are optional clipping diodes that are activated with the toggle switch. You may choose whichever diodes you prefer for these values.

LED FITMENT NOTE:

The diode spaces on this board are formatted for axial diodes, because typical LEDs are wider, pay attention to their fitment on the board. They can be staggered or offset if needed, to ensure they fit and are out of the way of other components. They may also be placed in the D3/D4 instead of the D1/D2 spaces if they fit better for you in that location. **3mm LEDs are recommended.**

NO TOGGLE? NO PROBLEM!

If you prefer to make this circuit without the clipping selector toggle switch, simply add a jumper instead. You can refer to the toggle bypass option illustrations on page 7 for this.

FILM CAPACITORS

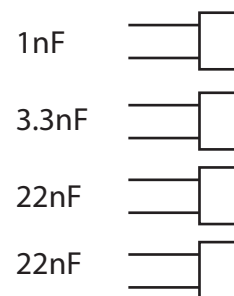

ELECTRO CAPACITORS

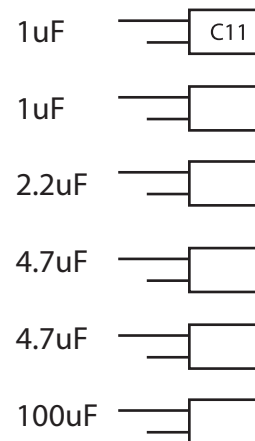

This page contains values according to the "YDR" version of this circuit

BILL OF MATERIALS

Bill of Materials	RESISTOR	FILM CAP (B)	CER CAP (M)	ELEC CAP	TRANSISTOR	DIODE	IC	POTS	OTHER									
	2	47 R	1	1n	1	30p	2	1u	1	2N5458	1	1N4001	1	LM308	3	A100K	1	SPDT
	1	560 R	1	3.3n	1	100p	1	2.2u			2	1N34A		/ OP07				ON/OFF/ON
	2	1K	2	22n			2	4.7u			2	option						
	1	1.5K					1	100u										
	1	10K																
	2	100K																
	2	1M																
1M ==>	1	(PDR)																

NOTE: Off board components are not listed (indicator LED, input/output jacks, power input jack, footswitch)

SMALL COMPONENT TABLE

(Small components may be taped down here)

RESISTORS

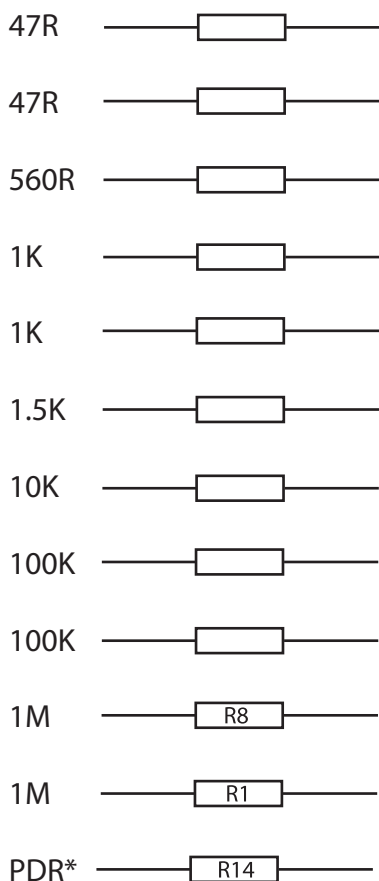

* Pull down resistor (PDR) is not present in the original circuit, it is added to help eliminate popping when the effect is powered on. Recommended value to use is 1M resistor

TRANSISTORS

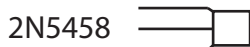

CERAMIC CAPACITORS

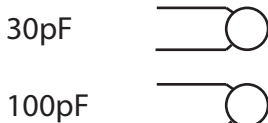

DIODES

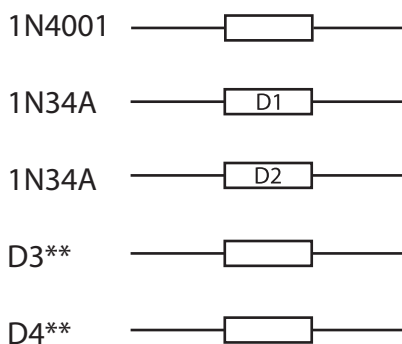

**D3/D4 are optional clipping diodes that are activated with the toggle switch. You may choose whichever diodes you prefer for these values.

OMITTED FOR THIS CIRCUIT
(leave these spots on the PCB blank)
R10, R13

FILM CAPACITORS

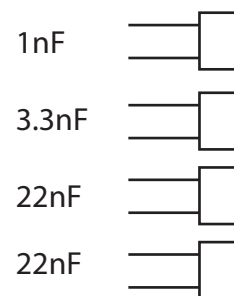

ELECTRO CAPACITORS

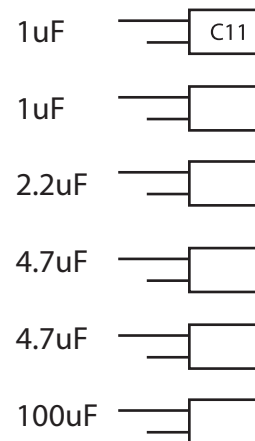

STOCK DIODE NOTE
The original YDR circuits were said to have contained 1N34A germanium diodes, but many people have reported that more current YDR pedals contain 1N270 or SH270 diodes.

NO TOGGLE? NO PROBLEM!

If you prefer to make this circuit without the clipping selector toggle switch, simply add a jumper instead. You can refer to the toggle bypass option illustrations on page 7 for this.

Refer to the illustration below when attaching components to your PCB

(wire length, boards, and pots are not shown to scale. They have been sized to fit this page for illustration purposes)

Board mounted pots
(see page 7a for pot mounting)

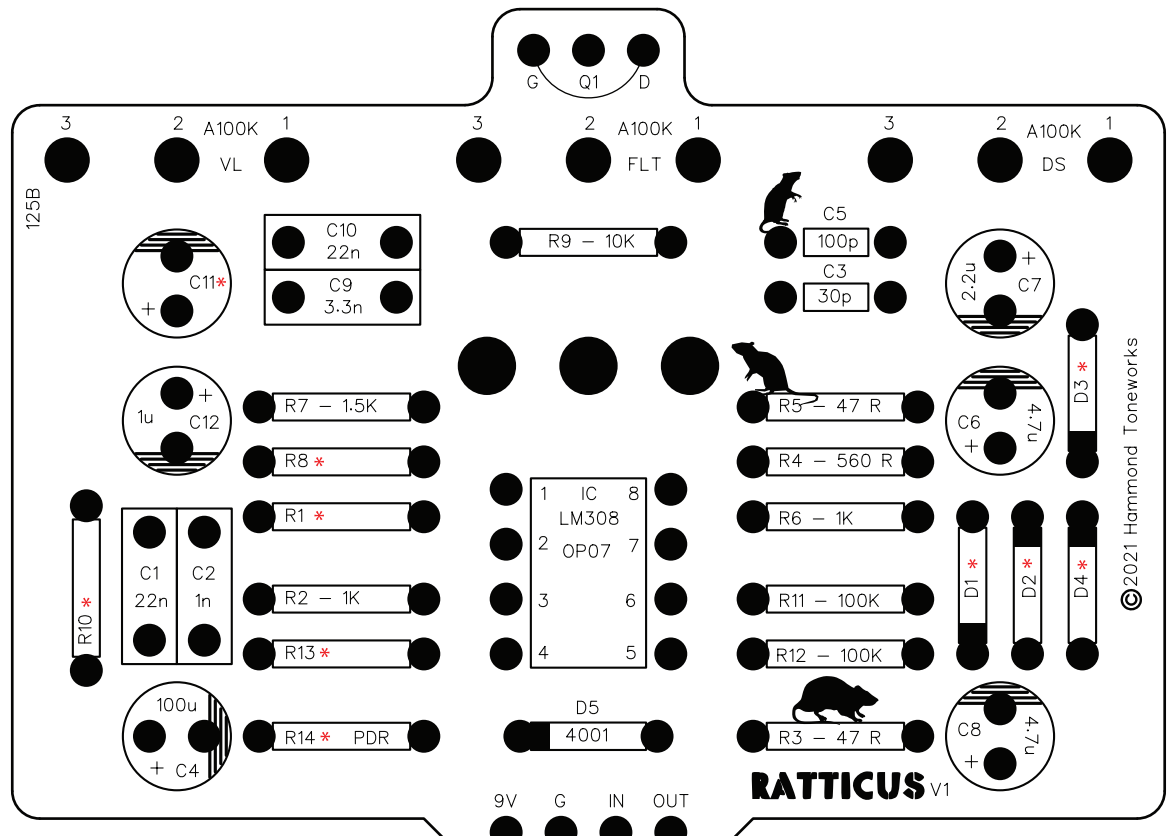
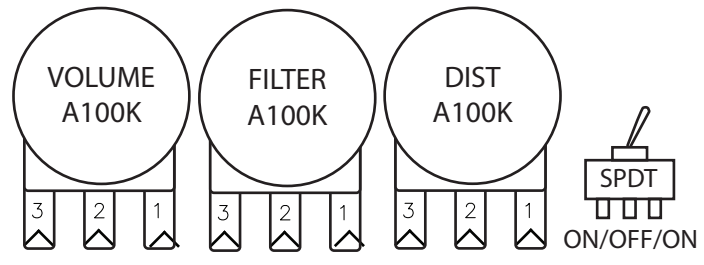

TOGGLE BYPASS JUMPER OPTIONS

The illustrations below show where to install a jumper if you would like to only use one set of clipping diodes like the original circuits and omit the toggle switch completely. If you leave all three pads unpopulated, then the clipping diode section will be bypassed completely.

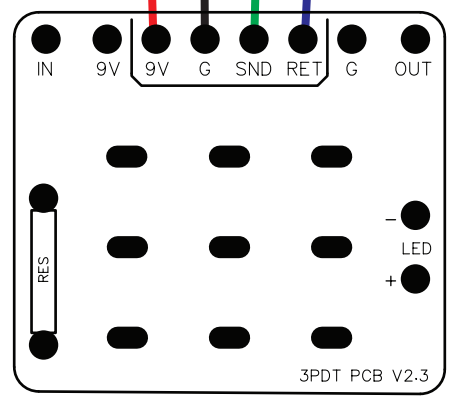
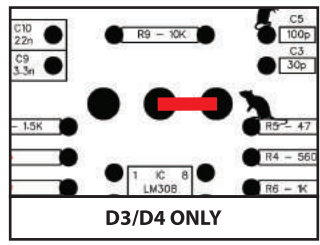
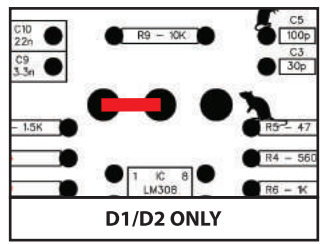

(3PDT PCB OPTIONAL)

EVEN MORE TOGGLE OPTIONS
Don't care for the boost mode? You can use a SPST ON-ON toggle switch in place of the SPDT. Doing this will give you the option of toggling between the D1/D2 set and the D3/D4 set of clipping diodes, eliminating the middle boost option.

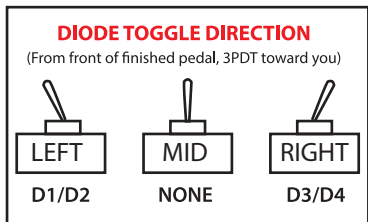

Bill of materials on page 6

* See page 10 for note on value discrepancies

Refer to the illustration below when attaching components to your PCB

Toggle Tip:
The SPDT switch will work properly regardless of its orientation. No need to worry about pin numbering. If it is on the pot side of the board then you're good :)

BOARD MOUNTED POTS (PCB REAR VIEW)

(Pots are not shown to scale. They have been sized to fit this page for illustration purposes)

EXAMPLE VIEW

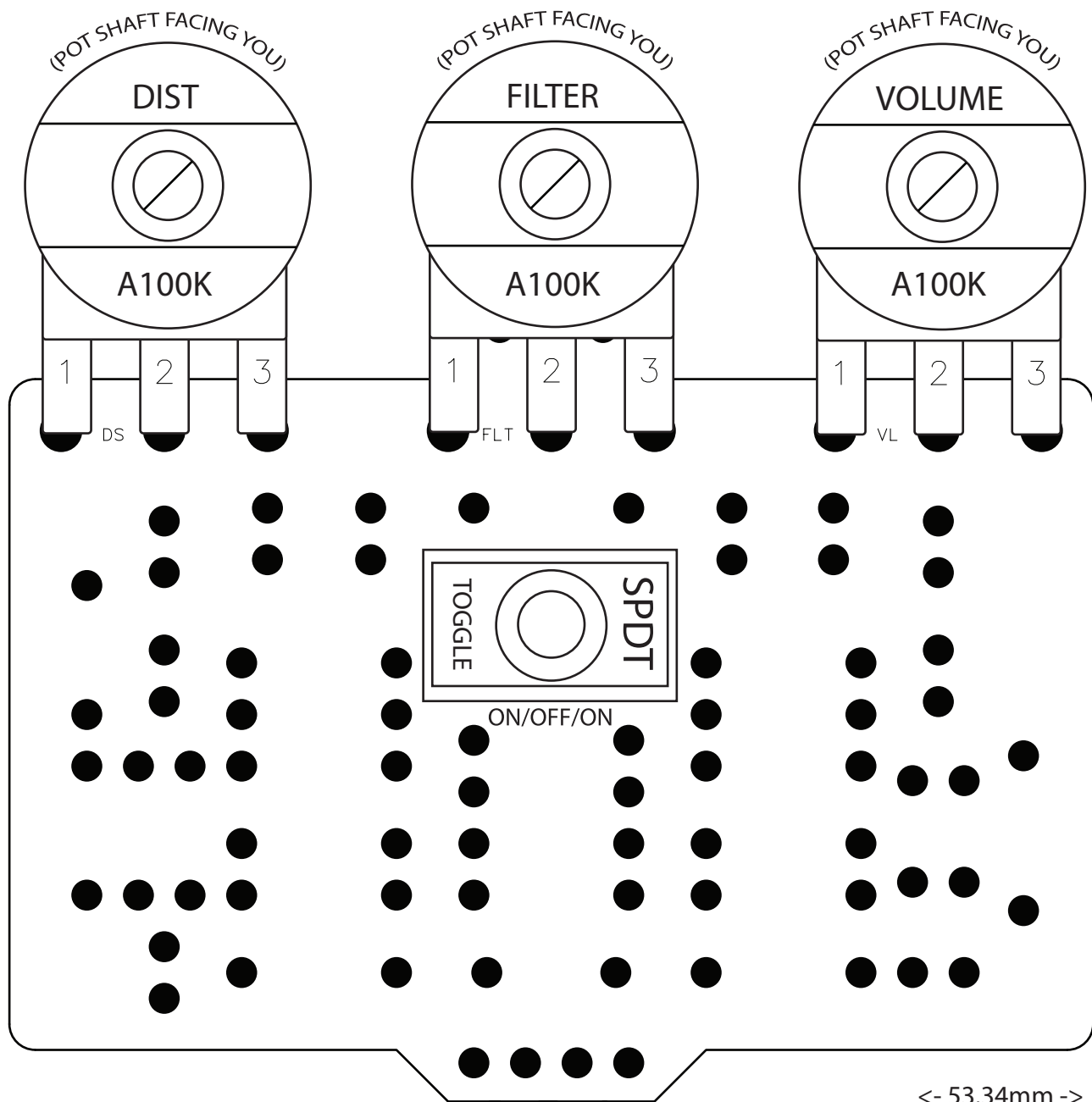
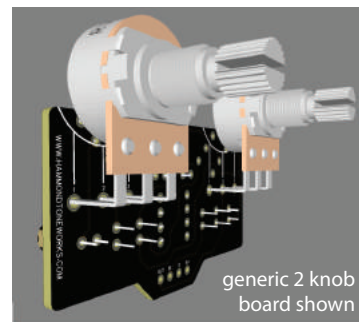

(PCB REAR VIEW)

A 3PDT PCB board is included with your effect board to simplify the offboard wiring process. You may use your own method of offboard wiring if preferred. The illustration below is recommended if you are using the included 3PDT PCB. As long as the effect PCB receives the correct 9V, Ground, In, and Out connections, it will work properly. The method below allows the pedal to be powered using a common standard modern 9V positive sleeve/negative center power supply.

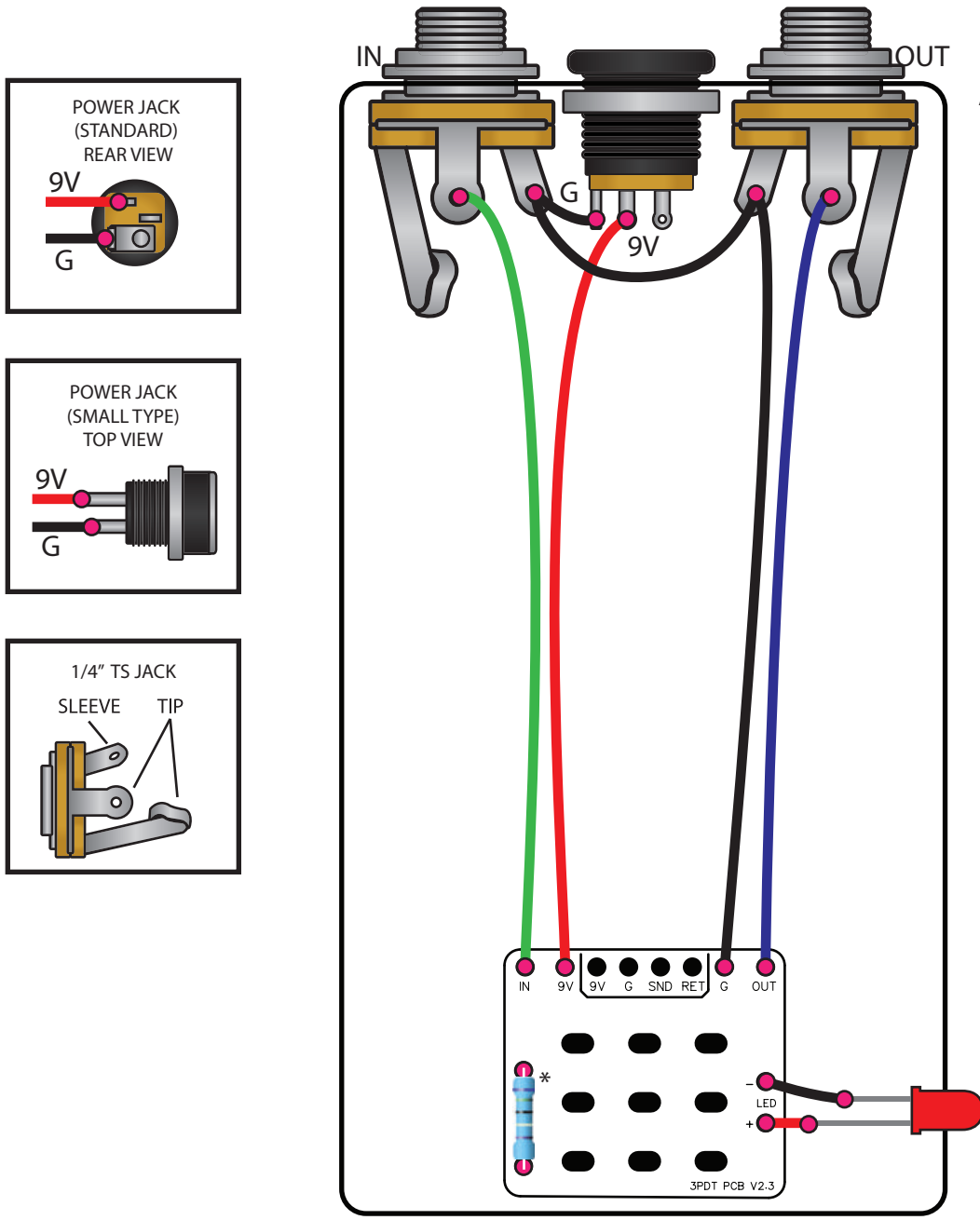

Audio jacks rotated for illustration purposes

NOTE:
If using a 3PDT PCB, it is easier to solder all wires and components first, and then solder the 3PDT switch to the board last.

● = Solder point

* LED resistor can be any value of your choice. Typical recommendation is 4.7k for normal red diffused LEDs, but may require up to 33k or so, depending on LED type and color.

The following wiring is recommended only if no 3PDT board is available. As long as the effect PCB receives the correct 9V, Ground, In, and Out connections, it will work properly. **A 3PDT PCB board is included with your effect PCB to simplify the offboard wiring process, if you would like to use the included 3PDT board, see page 8.** The offboard wiring method below allows the pedal to be powered using a common standard modern 9V positive sleeve/negative center power supply.

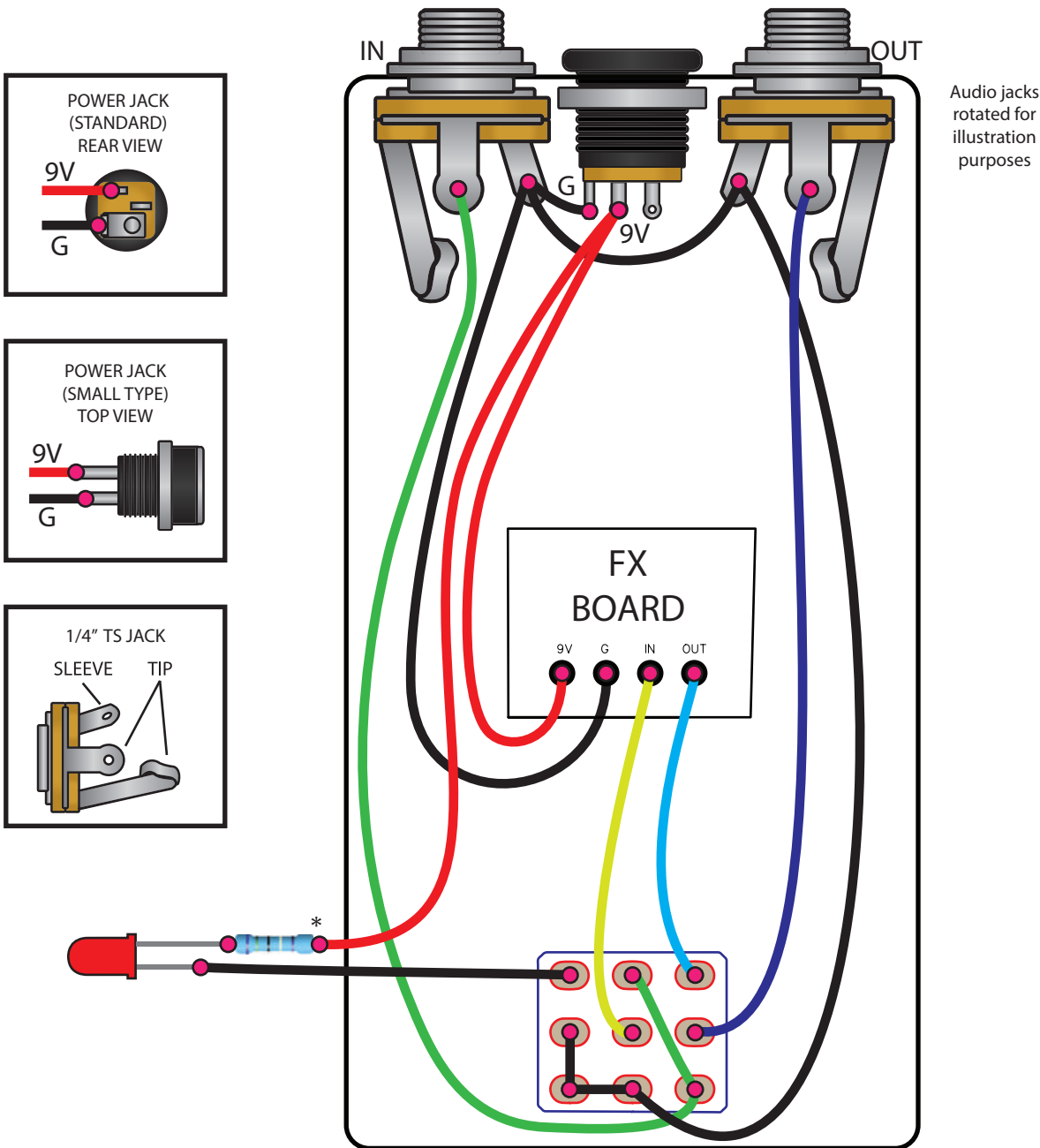

Audio jacks rotated for illustration purposes

● = Solder point

* LED resistor can be any value of your choice. Typical recommendation is 4.7k for normal red diffused LEDs, but may require up to 33k or so, depending on LED type and color.

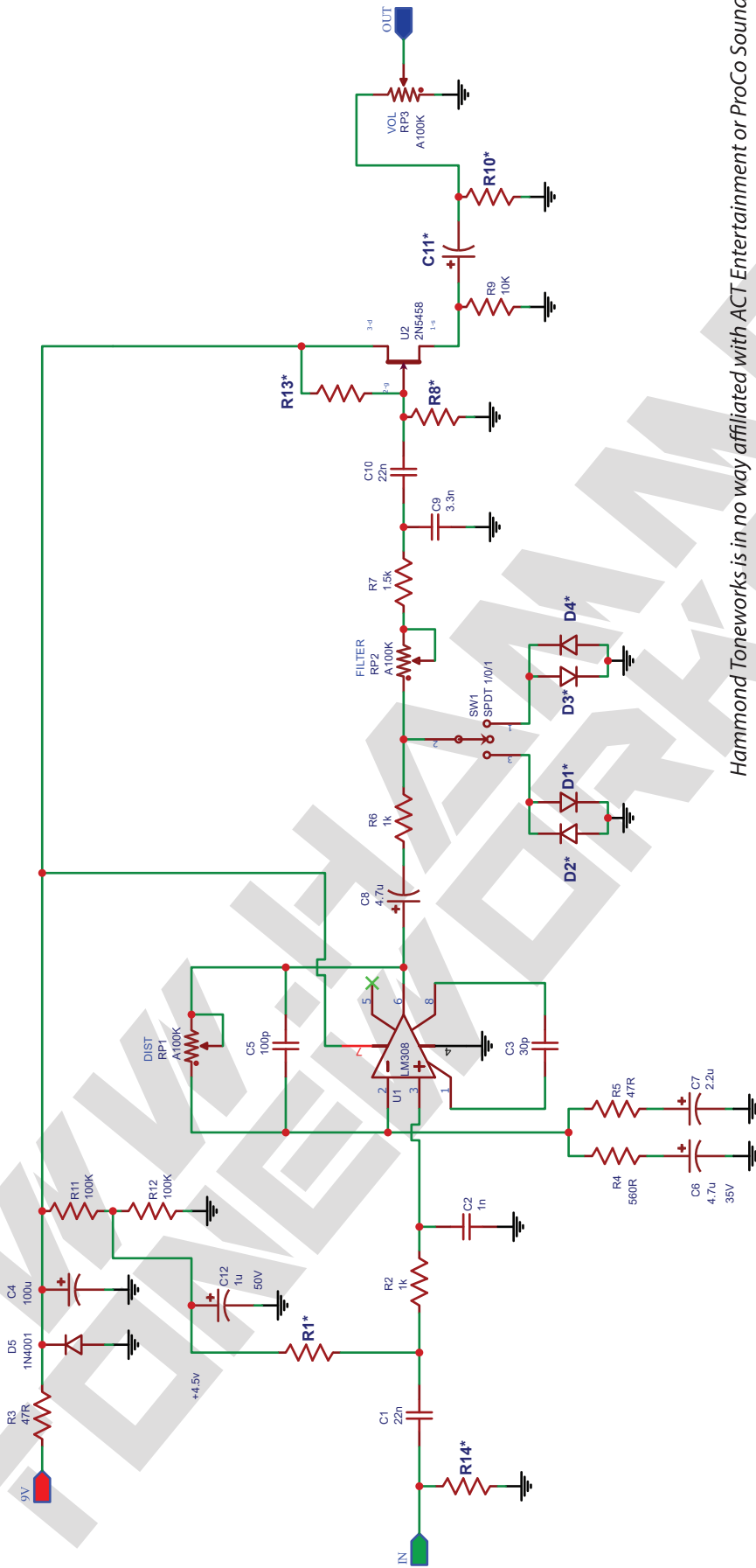

Hammond Toneworks is in no way affiliated with ACT Entertainment or ProCo Sounds
The use of "RAT" and related product names are strictly for reference.

PART	RAT	RAT 2	TURBO	REISSUE	YDR
R1	1M	2.2M	2.2M	1M	1M
R8	1M	1M	2.2M	1M	1M
R10	----	10K	10K	----	----
R13	----	----	2.2M	----	----
R14	----	2.2M	2.2M	----	----
C11	1u	10u	10u	1u	1u
D1/D2	1N914	1N4148	LED	1N4148	1N34A

* = Circuit option

CIRCUIT OPTIONS:
This board is able to be assembled to the version spec of your choice. The chart to the right gives the common component values that were present during their respective version of the original circuit. D2/D3 is not present in the original circuits, and are added to this pcb as additional clipping options that may be populated with your preference.

PRINT THIS PAGE ACTUAL SIZE

TAYDA DRILL TEMPLATE
 HT125B-RT-08 (Toggle, small DC)
 HT125B-RT-12 (Toggle, large DC)
 HT125B-RN-08 (NO toggle, small DC)
 HT125B-RN-12 (NO toggle, large DC)

125B
Top Jack Drill Template
 INLINE 3 KNOB
 Including drill size

DIRECTIONS:

1. Cut along dotted lines, and fold along the solid outline to preshape the paper template.

2. Carefully align template to the empty enclosure (without bottom lid) and tape in place to the enclosure.

You can also tape the corners of the template together once it is attached, to have a "cast" paper template ready if drilling more than one enclosure.

3. Using a steel punch, mark the drilling holes in the center of each cross. (mind the number of knobs) The punch should mark the enclosure even through the paper.

4. Remove template and check spacing on punched drill markers to ensure that everything will fit nicely. It's better to find out now than later. A common issue is the 1/4" jacks being too high, low, or offset. Hold a jack centered on the punch mark to see the clearance and make sure the lid will close (requires 2mm clearance from the open end of enclosure). Re-punch the drill markers if needed

5. Drill away!
 Take your time. It's more rewarding to be patient and have a properly drilled enclosure than to rush and be out of alignment.

TIP:
 After drilling, check your top jack fitment. Make sure you can fit both audio and power jacks in place properly. Top jacks are a tight fit, if one is off, bore out the hole slightly to get a good position if needed, no more than 1mm extra, as the external washer still needs to be able to have enough space around the hole to grab the enclosure.

Max knob diameter: 16mm

Note:
 Some power jack diameters may be smaller than 12mm. Please refer to your preferred power jack spec sheet to find the diameter needed. The standard threaded DC jacks typically require a 12mm hole, and the smaller two prong DC jacks typically require an 8mm hole.

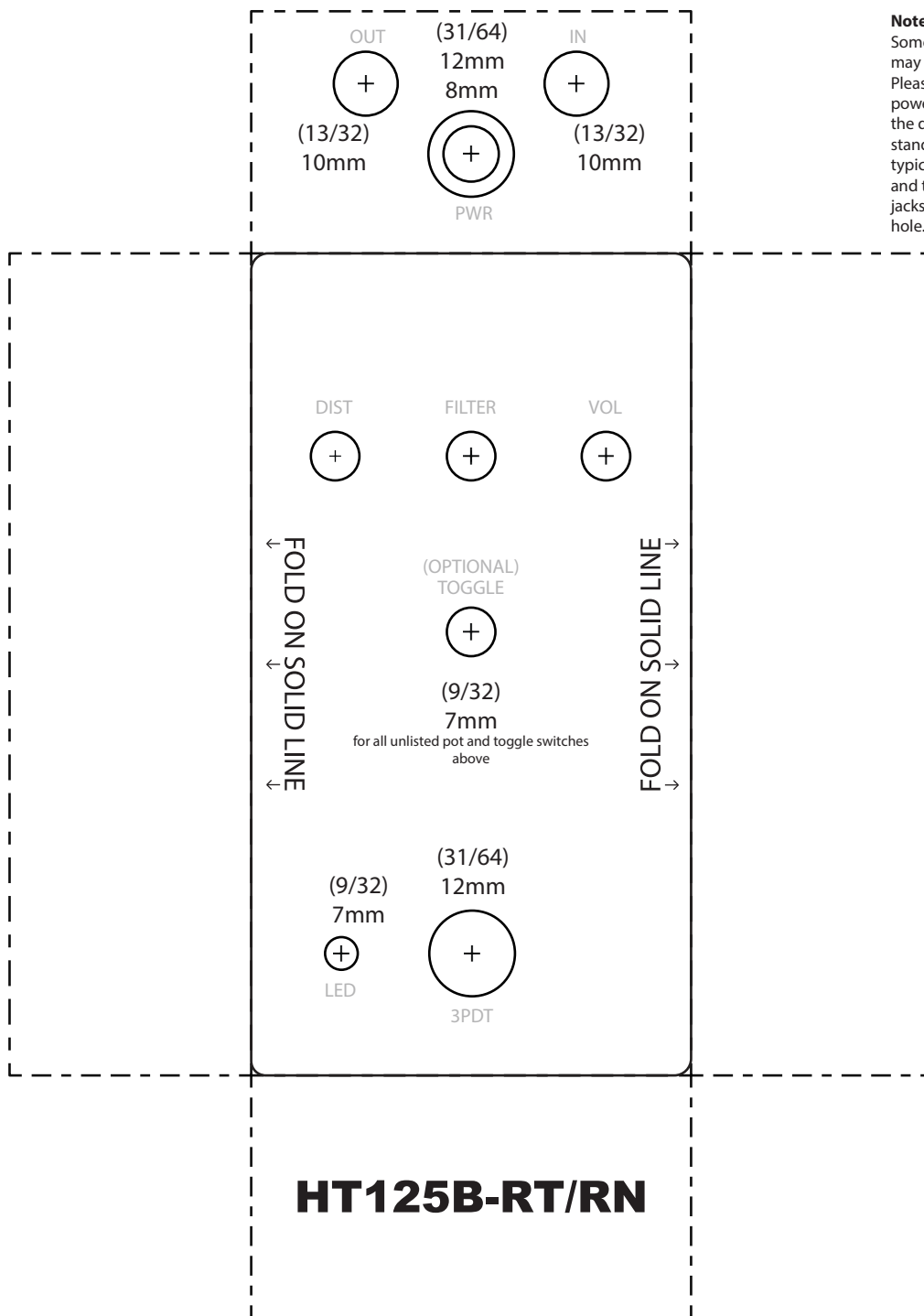

* This template and its measurements were calculated using manufacturer's specs and physically tested on Tayda branded size 125B enclosures.

Hammond Toneworks is in no way affiliated with Tayda Electronics